

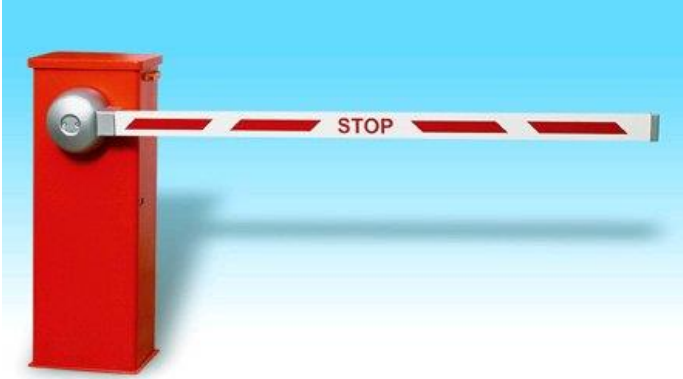

FALCON BARRIER



TECHNICAL MANUEL *'13 Bariyer Board Rev.05/01*



CONTENTS

Warnings, Technical Specifications, Installation	4
How to use? How it works? Maintenance-Repair, Transportation and Storage	4
Important notifications	5
Definition	6
Physical Specifications	6
Electrical Specifications	6
Dimensions	6
Mechanical Parts	6
Barrier Trunk	6
Base Installation	6
Gearbox	6
Gearbox Motor	7
Barrier Arm	7
Electronic Control	7
Main Control Board	7
LED Configurations	8
Closing Method	8
Manual Closing (with button)	8
Time Adjusted Automatic Closing	8
Adjusting Automatic Closing Time	8
Closing After Vehicle Passage	9
Remote Control	9
Flashing Light	9
Current Overload / Collision Protection	9
Smart Arm Adjustment	9
Emergency Mode Key	10
Counters / Passing Info	10
Sensor Control	10
Remote Control / Button Control	11
Manual Opening Lever	11
CH-TECH Remote Control	11
Main Board Connection Diagram	14
Barrier Installment (blow-up diagram)	16



WARNINGS

ATTENTION PLEASE!

- ✓ Before using this device, read all instructions in the operating manual.
- ✓ Keep these instructions for future reference.
- ✓ Do not install the device on soft or mobile surfaces.
- ✓ Do not allow any object to get into contact with the power cable of the device.
- ✓ Do not place power cable on pathways.
- ✓ Do not perform maintenance work by yourself. When needed, call the authorized service.

TECHNICAL SPECIFICATIONS

POWER	200-240 V AC
POWER CONSUMPTION	300 W
TRUNK	2 mm 304-quality stainless steel or 2mm DKP metal sheet with electrostatic paint
OPERATING TEMPERATURE	(-20) – (+60)° C
ARM LENGTH	330 cm, 480 cm and 600 cm (depending on the model of device)

INSTALLATION

Before installing the barrier, in order for the steel anchors to provide strong grip; make sure thickness of the hard surface has a minimum depth of 15-20 cm.

Barrier Installation Kit includes Base Installment Plate, 8 pieces of steel anchor, 8 pieces of screw & a nut set

1. Place the Barrier Base Installment Plate, Photocell and Arm Support Column where they are to be fixed and mark the screw holes.
2. Using a drill with 15 mm bit, drill 8 cm-deep holes on previously marked points. While drilling screw holes, make sure the drill is in upright position.
3. Embed eight steel anchors in the drilled holes with the help of a hammer.
4. Before placing the Barrier Base Installation Plate on the surface, make sure that the Power Cable and Cables for the Photocell and Arm Support Column can be passed securely through the center of the Barrier Base Installation Plate.
5. After the final control, drive four screws in without leaving any space in between the base and the surface.
6. Place the Photocell and Arm Support Column so that the Photocell Transmitter Apparatus faces the barrier trunk and then tighten it without leaving any space in between.
7. Connect the power cable to 220 VAC with a 10A fuse.



HOW IT WORKS? HOW IT IS USED?

1. If the photocell is to remain active, the cable running from the Arm Support Column should be connected according to the connection way of XL3 connector.
2. Barrier Arm is anchored to stand properly with the help of Arm Holding Apparatus and its related bolts.
3. 220 VAC current is fed to the transformer inside the Barrier Trunk.
4. Related button terminals are connected according to the connection way of XL6 connector.
5. Barrier is tested by executing open/close commands after the installation.
6. If the 90° angle is not set appropriately, the right angle is obtained by sliding the Proxy Sensors located on the Gearbox Installation Plate and it is adjusted with the help of a nut under the pressure of Stoppers.

MAINTENANCE-REPAIR

Maintenance of barrier is performed by the authorized technical service unit according to the maintenance procedures. Standard once a 6-month periodic control and maintenance will extend functional life of the barrier as well as increase its efficiency. Maintenance periods and frequencies may differ in reference to climate and operating conditions.

In case of breakdown, immediately contact authorized technical service unit.

UNAUTHORIZED PERSONS MUST NEVER BE ALLOWED TO PERFORM ANY MAINTENANCE OR REPAIR WORK.

TRANSPORTATION AND STORAGE

When transporting, the products must be in their original packaging. Warnings and instructions on packaging must be strictly followed during loading, transporting and stacking. No more than 3 products must be stacked together.



IMPORTANT NOTIFICATIONS

- Make sure that there is at least a 3-meter safety clearance between the barrier and loading gates.
- Do not permit pets to play under the barrier arm.
- Protect your equipment with a proper electrical grounding.
- Photocell and Arm Support Column must be used to ensure proper functioning of the barrier.
- Current Overload / Impact Intensity and Smart Arm adjustments of the device must be made in accordance with the changing physical conditions.
- Do not allow unauthorized persons to perform maintenance and repair work on the equipment.
- For connection of external peripheral units to be connected to the barrier, seek assistance of Authorized Technical Service.
- Do not extend or truncate the barrier arm without consulting with the authorized technical service unit.
- Do not try to pass thru the barrier before access approval is granted.
- Do not try to pass under the barrier arm before it fully completes its open/close cycle.
- Do not try to pass through the space above / under the barrier.
- Do not apply water (or other liquid) directly on the barrier by using hose or similar tools.
- If the automatic closing feature is on, keep in mind that after the Barrier Arm is lifted, unless allowed access is realized within a preset time interval, the command will be cancelled and then the arm will close.
- Comply with the operating manual, as well as warnings and instructions on the equipment.

ATTENTION

As the ballance spring is on DO NOT activate barrier without connecting the arm...!



1. DEFINITION

Barrier systems are used in parking lots, turnpike entry, exit and toll gates, entry and exit from building or apartment complexes in order to control vehicle flow with an automated access system and prevent entry of unauthorized vehicles.

2. PHYSICAL SPECIFICATIONS

2.1. Electrical Specifications

Power feed for Falcon barrier is 200-240 VAC while its power consumption is 300 W. Its operating temperature is between -20° and +60° C. Thanks to its battery charge unit in the Barrier Main Control Board, in case of power outage, the barrier system performs up to 250 on and off operations smoothly without any interruptions. In case of full battery depletion due to extended power outages, it is still possible to operate the barrier arm manually. Barrier with battery is an OPTIONAL feature.

2.2 Dimensions

Height of the barrier trunk is 102 cm, width 23.5 cm and depth 37.5 cm. Length of the arm can be selected between 2 and 6 meters. The arm can also be produced at any desired intermediate length. The width of the rectangular arm is 7.5 cm and the breadth is 3.2 cm. while the cylindrical arm has a diameter of 6 cm. For more detailed information about the barrier trunk, please check the section for technical drawings and diagrams.

3. MECHANICAL PARTS

3.1. Barrier Trunk

Barrier trunk is comprised of top cover, front cover and the main body. Top cover has a width of 37.5 cm and a depth of 23.5 cm. In case of rain or snow, this cover prevents water entering inside. Height of the front cover is 88 cm and the width is 26 cm. With the help of front cover key, the cover can be completely detached. This feature allows easy access in case of a breakdown. The main body has a height of 100 cm, a width of 35 cm and a depth of 21 cm. The material used for the trunk is 2 mm 304-quality stainless steel or 2mm DKP. Besides the standard colors, desired color from the electro-static dust paint catalog can be applied upon request. With its original design, Falcon Barrier System provides decorative appearance for both indoors and outdoors.

3.2. Base Installment

Thanks to its Base Installment Apparatus, barrier trunk is easily fastened to the ground with four M12 stud bolts. Trunk base has a width of 38 cm and a breadth of 24 cm. Trunk is placed on the ground and fastened with special stud bolts and nuts. The section to be fastened to the ground is again made of 2 mm 304-quality stainless steel or metal sheet painted with electrostatic paint. If the surface is level, Base Installment Apparatus can be used as a stencil while M12 stud bolts are directly fastened to the ground. If the surface is not level, first the surface is leveled by laying concrete and then the base installment plate is anchored to the surface by help of its special bolts. Falcon barrier is subsequently mounted on top of these anchors.

3.3 Gearbox

Gearbox is mounted inside the barrier trunk by means of the gearbox trunk installation and bearing flanges. With the help of its gears, gearbox transfers the motion originating from the inlet gear to the gearbox shaft. The gearbox shaft connection thus



enables the barrier arm to move in correlation with the gearbox inlet gear. The gearbox rear balance arm which is secured to the back of the gearbox shaft by a wedge moves in unison with the barrier arm. Load counterbalancing function of the barrier arm is achieved with a spring connected to the gearbox rear balance arm. Stoppers placed at the limit points of the balance arm once again ensure smooth and safe stoppage of the barrier arm in open and close positions. In case of a breakdown, these stoppers prevent barrier arm to move beyond its operational limits. Stoppage positions can be adjusted once again through the sensors, which are located in the slots of the gearbox installation plate, identifying open and close positions of the barrier arm. Open and close positions of the barrier arm can be adjusted as desired (In open position the barrier arm can be set either 90° or 80° in reference to the ground).

3.4. Gearbox Motor

A balance wheel is mounted on the gearbox motor. This balance wheel via its V-belt provides motion to the gearbox inlet gear. In another words, motion of the barrier arm depends on the input to the gearbox motor. Gearbox motor works in bidirectional fashion with 24 V DC. Control of the gearbox motor is performed by Power Relays which, in turn, are controlled by the Main Control Board.

3.5 Barrier Arm

Length of the barrier arm can be 2 m, 6 m or in between these lengths. Entire arm is made up of aluminum. Barrier arm is equipped with reflector red stripes and a STOP sign that are visible at nights. The gearbox shaft connection enables barrier arm to work in correlation with the gearbox. As long as the gearbox is in motion so is the barrier arm.

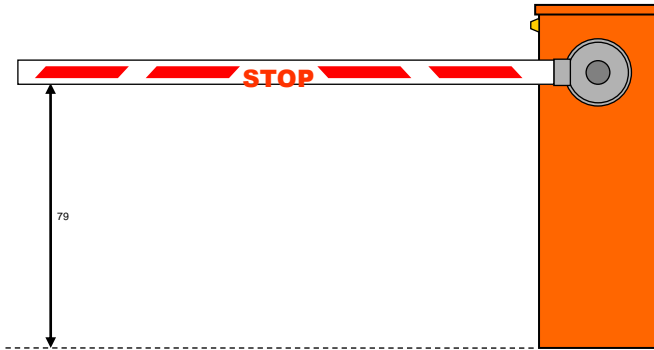

4. ELECTRONIC CONTROL

4.1. Main Control Board

Designed as a microcontroller based main control board, it is therefore controlled by PIC16F886 processor of Microchip. All procedures are determined and executed by the processor. Input of the Main Control Board is supplied through the power transformer located at the bottom of the barrier trunk. Optional batteries located next to the transformer are again charged through the main control board. In case of power outage, main control board draws the necessary power from the batteries in order to operate without interruption. Located on the main control board, there are DIP switches and jumpers enabling barrier to perform desired tasks as well as LEDs that provide visual display of functions performed. These are:



4.1.1 LED CONFIGURATIONS

- L1 KIRMIZI LED:** Indicates 24VDC power is ON
- L2 SARI LED:** Indicates 18VDC power is ON.
- L3 YEŞİL LED:** Indicates 5VDC power is ON.
- L4 SARI LED:** It works with flasher.
- L5 KIRMIZI LED:** It is active when pass relay is active..
- L6 YEŞİL LED:** It is active when emergency button is pressed.
- L7 YEŞİL LED:** It is active when down_button is pressed. Arm starts moving down.
- L8 YEŞİL LED:** It is active when up_button is pressed. Arm starts moving up.
- L9 KIRMIZI LED:** It is active when IR transceiver receivin data correctly and there is no obstruciton.
- L10 KIRMIZI LED:** It is acitve when arm is at down position.
- L11 KIRMIZI LED:** It is active when arm is at up position.
- L12 YEŞİL LED:** It is active when UP relay is ON.
- L13 YEŞİL LED:** It is active when DOWN relay is ON.
- L14 SARI LED:** It is active when excessive current is sensed.

4.1.2 Closing Procedure

There are three possible ways for the barrier arm to open and then to return to the closed position following completion of the vehicle passage. The first one is called manual closing where user pushes the appropriate button to perform the task. The second one is where the barrier arm automatically closes by an adjustable timer that can be set to any duration within the 1-60 second range. Third one is where the barrier arm closes after the vehicle passes in front of the photocell.

4.1.3 Manual Closing (with button)

The barrier can be brought to closed position by pushing the close button.

4.1.4 Time Adjusted Automatic Closing

In order for automatic closing procedure to be activated, the SW1/5 switch on the Main Control Board must be switched to ON position. In case this switch remains in OFF position, barrier arm then can only be closed either by the user himself or after the vehicle passes in front of the photocell.

4.1.5 Adjusting Automatic Closing Time

While SW1/5 is ON, auto close option becomes active and arm starts moving down after adjusted time is finished. The time is adjusted via potentiometer (VR1) between



1 and 60 seconds. If VR1 is turn CW it reaches min time and if VR1 is turn CCW it reaches max time.

4.1.6 Closing After Vehicle Passage

While SW1/2 is ON, auto close after vehicle passes in front of the photocell or loop sensor is active. The arm waits for 500ms and then starts moving down after vehicle passes in front of the photocell or loop sensor

4.1.7 Remote Control

If a remote control unit is desired to be added to the barrier system, the remote control unit's contact ends providing dry contact are connected to the OPEN button. As a result, each pressing of the button corresponds to an OPEN command.

4.1.8 Flashing Light

ORANGE WARNING LIGHT located on the barrier trunk may be in variety of modes depending on the motion of the barrier arm as well as the reason for this motion. If the barrier arm moves after pressing the buttons or as a result of the photocell circuit sensing an object, then the warning light flashes. When the barrier arm is in upright position, mode of the flashing light changes. If the barrier arm is raised by pressing the open button, the warning light remains constantly alight. If the barrier arm is raised as result of the photocell sensing an object, the warning light resumes flashing as long as the barrier arm remains in upright position. Once the barrier arm is in down position for whatever reason (by pressing the close button or automatic closing), the flashing light remains always off.

4.1.9 Current Overload / Collusion Protection

If the barrier arm hits an object during closing / opening process, it senses the situation; pauses for 2000 milliseconds and then proceeds to reverse direction. Sensitivity of excessive current is adjusted via potentiometer VR2.

4.1.10 Smart Arm Adjustment

This adjustment varies according to the arm length. When the variable resistor is turned counterclockwise, the impact intensity increases. When the variable resistor is turned clockwise, the impact intensity decreases. If the variable resistor is turned too much in clockwise direction, then the barrier arm may react as if it hit some kind of object even though it did not; thus, this situation may cause the system to fall into a cycle of continuous open and close modes. Therefore, it must be made sure that VR2 variable resistor is not in full clockwise position. When adjusting, it is perfectly possible to set the impact intensity to the desired level by simply obstructing the Barrier Arm with a hand. If the flashing light is continuously giving off two short and one long signals, this indicates that the barrier system has initiated the overload protection mode in order to protect itself.

Current overload protection system for the barrier arm is provided through a separate arrangement. According to this arrangement, if the barrier arm encounters any counter-pressure when in motion (up or down); the barrier arm briefly pauses and then moves in the opposite direction from the point of counter-pressure. When the barrier arm again detects an obstacle, the system repeats this back and forth motion routine for three times and when it is understood that the initial command cannot be fulfilled in the up or down direction, the system initiates Waiting Mode for the power and current overload protection circuits. In this case, the barrier arm remains stationary in the direction of motion for period of five minutes. At the end of this period, the barrier arm again activates the same routine and then the system switches to either normal operation mode or Waiting Mode according to the last position of the barrier arm.



When the mentioned routine is repeated five times in a row, in another words when the five minute period is completed five times in a row, if the barrier arm still senses the current overload routine (if the barrier arm cannot move up or down), this time the barrier system lapses into the Sleep Mode (Flashing light gives off slow and intermittent signals). In order to emerge from the Sleep Mode, power of the barrier system should be turned off and then on again or XL1 connectors must be plugged out and then plugged in again.

PLEASE ASK THE INSTALLATION TEAM WHETHER THE SMART ARM ADJUSTMENT IS DONE.

4.1.11 Emergency Mode Key

Number 5 and 6 terminals of the XL5 connector on the main control board is for the key that is used in controlling the barrier arm in emergency situations. When the key that is connected to this jumper is in ON position, the barrier performs its normal functions. If the key is switched to OFF position, regardless of the position of the barrier arm, it starts moving up and stops upon reaching complete upright position. Until the key is switched back to the ON position, the barrier loses all of its functions, remains in open position and allows free access. This key should be used for emergency situations. In case of any emergency situation (fire, earthquake etc.), this key is activated to keep the barrier in open position so that free access is allowed. Usage of this key is optional, thereby these terminals are shorted during the manufacturing process. If a key is to be connected, mentioned short circuit must be eliminated first and then a key with ON/OFF modes should be connected to these same terminals.

4.1.12 Counters / Passing Info

Number 1, 2 and 3 terminals of the XL6 connector on the main control board are for connecting external counters to the main board. When arm reaches to the up position and photocell detects any pass, pass relay (RL3) becomes active around 500ms and pass signal received from here. Pin 1 is pass relay's NO pin, pin 2 is pass relay's NC, pin 3 is pass relay's COM pin. When RL2 becomes active L5 (RED led) also becomes active.

4.2 Sensor Control

Sensing process, whether there is an object that obstructs vehicle passage or closing of the barrier arm, is carried out by a sensor mounted within the barrier trunk. There are two kinds of sensors used in the barrier system. First one is an IR safety photocell composed of a receiver and transmitter module; the second one is a safety photocell with reflector. The receiver and transmitter module of the IR safety photocell must see each other in a fully facing manner. In order to ensure proper functioning of the safety photocell with reflector, reflector unit must be mounted perpendicular to the sensor while directly facing one another. This is the sensor that prevents barrier arm to descend in case a vehicle or an object stands under the barrier arm. If the barrier arm is in descending mode while an object is sensed, the barrier arm immediately reverses to opening mode. If the barrier arm receives a closing command while a vehicle is underneath, this command is executed only after the vehicle passes.

Standard manufactured barrier is equipped with only IR safety photocell. Safety photocell with reflector is an **OPTIONAL** feature. The safety photocell with reflector is supplied along with the barrier system only upon special request of the user.

4.3 Remote Control / Button Control



Remote control functions are provided by two types of remote control processes: with button and keyless systems. Key holder mountable button remote control unit with can control the barrier from 30 meters distance. When the button of the remote control unit is pressed, the barrier opens. Closing of the barrier is carried out depending on the appropriate selection of available choices: Time Controlled Automatic Closing or Vehicle Passage Controlled Automatic Closing or both. The keyless remote control unit is placed in an appropriate location (on the dashboard or inside the front bumper) inside the car. When the vehicle approaches to the barrier (approximately 3 meters), the barrier system senses oncoming vehicle thus carries out the automatic opening task. Once the barrier opens, the vehicle must proceed within about 30 seconds. For the button controlled process, there are two options. Opening of the barrier is controlled by connecting a button to the opening terminals of the barrier. While closing of the barrier can be achieved either by time controlled process or vehicle passage controlled process, it can also be done by connection of another external button to the barrier after canceling above mentioned two features.

5. MANUAL OPENING LEVER

As a result of some failure or extended period of power outage causing batteries to empty, the barrier arm may remain closed. In these kinds of circumstances, it is possible to raise the barrier arm with the help of a disc located behind the motor. However, in order to perform this task, all precautionary measures must be taken beforehand by turning off the electric power, switching off the main circuit breaker and dislodging one of the cable terminals of the battery.

ATTENTION: *While trying to raise the barrier arm with the help of the manual opening lever, sudden resumption of power and consequent motion of the barrier arm may cause some unwanted injuries.*

CH-TECH CONTROL UNIT (Single Relay, Bulding Keyless Type)

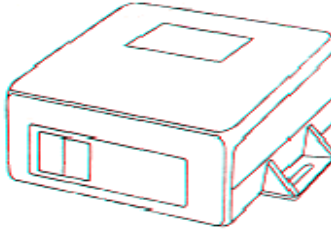

Matters to be heeded when installing the remote control unit:

- Central receiver box must be mounted inside the barrier. If it is installed about waist-high, the reception ability improves.
- Owners of vehicles with a keyless remote control unit must be careful not to park their vehicles too close (5 meters) to the barrier.



Control Function

When the system is in normal operational mode, LED light flashes in green. In this case, if the left button on the button remote control unit is briefly pressed, the control process is carried out. If the user has a keyless (without button) control unit, simply approaching to the main receiver box will suffice. The system will automatically execute the operation within a distance of 1-3 meters. However, the system will not accept code of the same user unless 10 seconds elapses after the initial attempt. Only upon completion of 10 second pause, the system resumes its control operations.

User Capacity

In the standard format, system can be programmed to recognize up to 125 remote control units. If requested, this capacity can be increased up to 500 remote control units.

Battery Life

Although depending on frequency of use, average battery life of a button remote control unit is about one year. In keyless (without button) units, however, average battery life is about 4-5 months.

Deletion of System Memory

It is possible to delete entire list of recognized transmitters. In order to perform a deletion procedure following steps should be observed in order:

- Notice that LED light is flashing in green.
- Remove the JP1 jumper located in the central box.
- Wait for one second before remounting JP1 back to its original slot.
- LED light will remain off for a while and then resume flashing in green again.

Therefore, entire memory of the system is deleted.

Introduction of a Master Control Unit for System Authorization

In order to introduce a master control unit for system authorization the following steps should be observed in order:

- Notice that LED light is flashing in green.
- Remove the JP2 jumper located in the central box.
- Press continuously on the left button of the control unit that is to be introduced as the main control unit for system authorization. When the LED light turns red, stop pressing the button and remount JP2 back to its original slot.

Now on, the system will recognize the Authorized Master Control Unit.

Introduction of a New User Control Unit to the System

In order to introduce a new user control unit to the system authorization the following steps should be observed in order:

- Notice that LED light is flashing in green.
- Keep pressing the left button of the authorized master control unit for two seconds. Now LED light will flash back and forth between red and green.
- If the new user control unit to be introduced is with button, introduction procedure can be completed by continuously pressing the left button of the control unit for three seconds. In a keyless (without button) unit, simply holding the unit in half a meter proximity to the system will suffice. The system will automatically recognize the keyless remote control unit.
- After the system recognizes the remote control unit, LED light will once again flash in green. If a keyless remote control unit is introduced to the



system, control procedure will be automatically carried out. In a button remote control unit, gate will open upon pressing the left button.

Deleting the Control Unit of the Last User Introduced to the System

In order to delete from the memory the control unit of the last user introduced to the system, the following steps should be observed in order:

- Notice that LED light is flashing in green.
- Keep pressing the right button of the authorized master control unit for two seconds. LED light will flash in red.
- In the same fashion, once again keep pressing the right button of the authorized master control unit for two seconds.

Therefore, the last introduced control unit is deleted from the system.

CH-TECH CONTROL UNIT

(Double Relays, Triger Module, New Type)

Brown	GND	Supplies power to system.
Red	+12VDC	First take out and then put in Board.
Yellow-Black	---	the "J1" which is on The Control
Yellow-Black	---	Press one of the button on the remote control and wait
Yellow	Relay1 NC	for some seconds until it gates the relay.
Green	Relay1 Com	
White-Blue	Relay1 NO	Note : <i>After you take out the "J1" and wait a long time</i>
Yellow	Relay2 NC	<i>(like 5 or 10 sec.) before putting it in the</i>
Green	Relay2 Com	<i>system resets all of the remote controllers.</i>
Blue-White	Relay2 NC	



MAIN BOARD

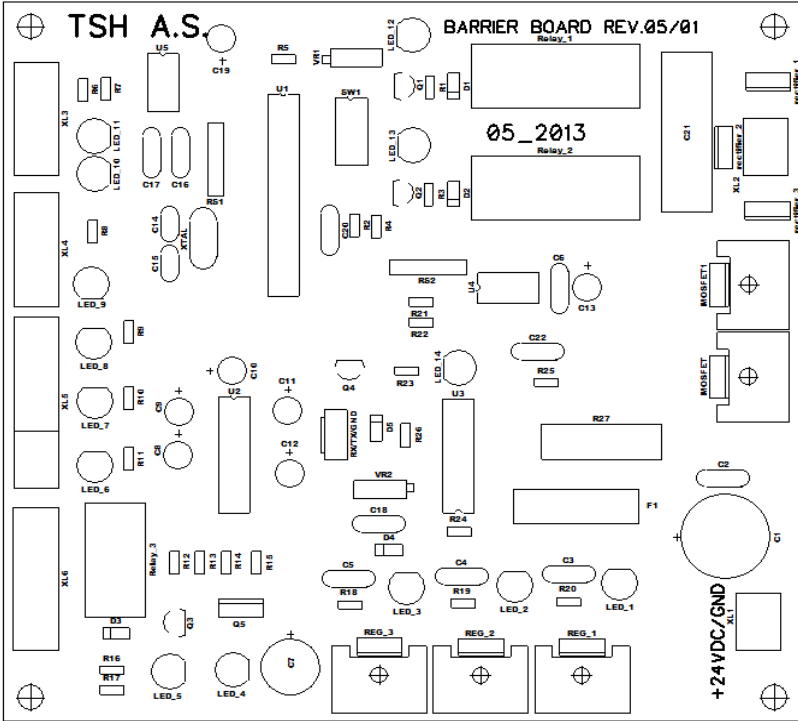

XL1

This connector is main 24VDC input which comes from power supply. All voltage levels are received from this supply and if L1, L2 ve L3 leds are ON then all voltages are delivered to the main board. F1 fuse is 10A.

XL2

Motor is connected to this connector. Yellow cable of the motor is connected to the pin1 and brown cable of the motor is connected to the pin 2.

XL3

Position switches are connected to this connector. These switches are used to determine the positions of the arm and deliver it the the processor. Proxy sensor are used as position switches. These sensors are detectind metal and its activation distance is 6mm max. When the balancing arm, which spring is connected, activates the sensor, releted led becomes active and processor sense the position. Pin 1 is data pin of the up switch, pin 2 is data pin of down switch, pin 3 is power supply (24VDC) of two sensors, pin 4 is ground for two sensors.

XL4



External photocell or LOOP sensor is connected to this connector. It is connected NC as normally. Pin 1 is power supply (24VDC), pin 2 is GND, pin 3 and pin 4 are input pins of external sensor and relay outputs of photocell or loop sensor should be connected to this pins.

XL5

Buttons are connected to this connector. If pin 1 and pin 2 connected together, related led becomes active and arm starts moving up. If pin 3 and pin 4 connected together, related led becomes active and arm starts moving down. If pin 5 and pin 6 are not connected together, Emergency position is becomes active and if arm is down it goes to up and waits until Emergency becomes inactive. So pin 5 and pin 6 always should be connected together.

XL6

When arm reaches to the up position and photocell detects any pass, pass relay (RL2) becomes active around 250ms and pass signal received from here. Pin 1 is pass relay's NO pin, pin 2 is pass relay's NC, pin 3 is pass relay's COM pin. When RL2 becomes active L5 (RED led) also becomes active. Pin4 and pin 5 are used as flasher outputs. L4 (YELLOW led) is flashing same time with external flasher.



BARRIER INSTALLATION BLOW-UP DIAGRAM

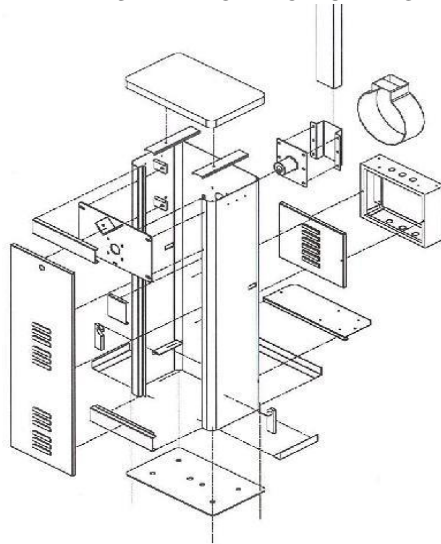

OUTER MEASUREMENTS FOR BARRIER TRUNK (SIDE VIEW)

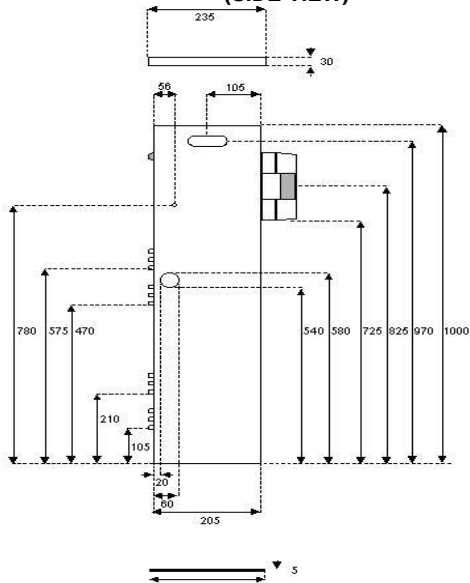



OUTER MEASUREMENTS FOR BARRIER TRUNK (FRONT VIEW)

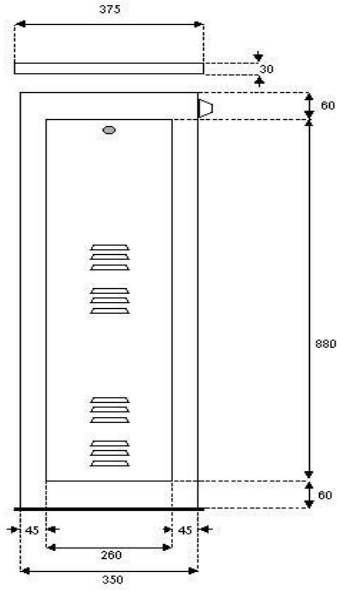

INNER MEASUREMENTS FOR BARRIER TRUNK

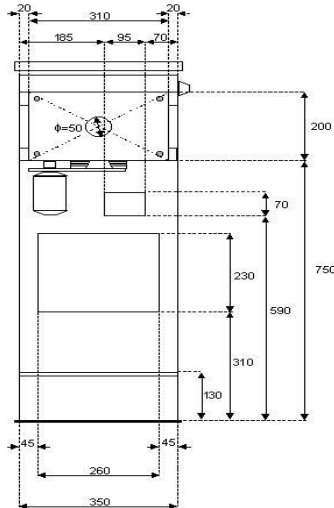



Istanbul 05.01.2004

CE COMPLIANCE DECLARATION

TSH Teknik Servis Hizmetleri Sanayi Ticaret A.Ş.
Büyükdere Cad. Akabe İş Merkezi No:78–80 Kat:2
34387 Gayrettepe/İSTANBUL

We solemnly declare that the name, type, model of product/products with serial numbers listed below is manufactured in full accordance with the required standards and stipulations of Low Voltage Devices Directive **(73/23/EEC; 93/68/EEC)**.

Name and Model of the Product:

CH-TECH Falcon Barrier

Applicable Standards:

prEN 12453, EN 50133-1



TSH TEKNİK SERVİS HİZMETLERİ SAN. TİC. A.Ş.

Headquarters:

Seyrantepe Mah. Çalışkan Sokak No: 9

Seyrantepe - İSTANBUL

Phone : (0 212) 279 00 06 pbx

Fax : (0 212) 280 38 04

Factory:

Seyrantepe Mah. Çalışkan Sokak No: 9

Seyrantepe - İSTANBUL

Phone : (0 212) 279 00 06 pbx

Fax : (0 212) 280 38 04

Service Headquarters:

Seyrantepe Mah. Çalışkan Sokak No: 9

Seyrantepe - İSTANBUL

Phone : (0 212) 279 00 06 pbx

Fax : (0 212) 280 38 04

Regional Service Unit:

KARTSİS ANKARA KART SİSTEMLERİ TİC. A.Ş.

Cinnah Cad. No: 98/3

06550 Çankaya /ANKARA

Phone : (0 312) 441 90 91

Fax : (0 312) 441 76 79

<http://www.tsh.com.tr>

TSH is a Çözüm Holding A.Ş. company.